

FE-13 Component Description

FE-13 180 Pendant Nozzle

Effective: April 2007
K-96-9200

P/N: 96-91401X-XXX (See Table)

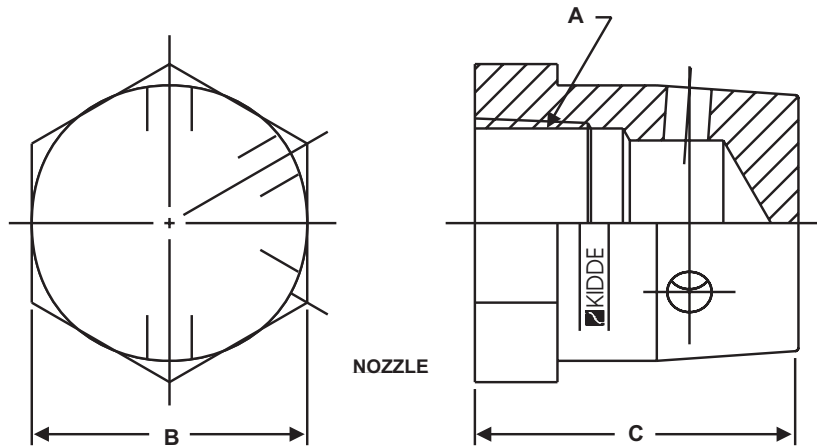

LABEL
P/N: 06-231865-876



Part Number	Thread A	Dimension B	Dimension C
96-174013-XXX	1/2 in. NPT	1-1/4 in. Hex	1.937 in.
96-174014-XXX	3/4 in. NPT	1-1/2 in. Hex	2.125 in.
96-174015-XXX	1 in. NPT	1-3/4 in. Hex	2.375 in.
96-174016-XXX	1-1/4 in. NPT	2-1/4 in. Hex	2.750 in.
96-174017-XXX	1-1/2 in. NPT	2-1/2 in. Hex	3.005 in.
96-174018-XXX	1-1/4 2 in. NPT	3 in. Hex	3.202 in.

A SELECTION OF ORIFICES ARE AVAILABLE FOR EACH NOZZLE SIZE. CONSULT YOUR KIDDE DESIGN, INSTALLATION, OPERATION, AND MAINTENANCE MANUAL FOR DETAILS.

This literature is provided for informational purposes only. KIDDE-FENWAL, INC. assumes no responsibility for the product's suitability for a particular application. The product must be properly applied to work correctly. If you need more information on this product, or if you have a particular problem or question, contact KIDDE-FENWAL, INC., Ashland, MA 01721. Telephone: (508) 881-2000.

Kidde Fire Systems
A UTC Fire & Security Company
400 Main Street
Ashland, MA 01721
Ph: 508.881.2000
Fax: 508.881.8920
www.kiddefiresystems.com